

CYRIL TYP 06





Art.-Nr.	262794		550	1/4
			380	
			350	
			mm	
				ZO

	 40min		 ≤ 0,5 kg	 3m	 PZ 2	 4	 300 mm	
--	-----------	--	--------------	--------	----------	-------	------------	--

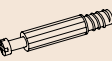

ID	ID			
17191	②	331*330*16	2x	1/1
17174	③	550*350*16	2x	1/1
17193	④	358*271*3	2x	1/1
17194	⑤	538*323*16	1x	1/1
14756	⑥	320*152*16	1x	1/1
17195	⑦	478*132*16	1x	1/1
14758	⑧	320*152*16	1x	1/1
17196	⑨	326*488*3	1x	1/1

8402,03		Ø8	21102,00		Ø1,6x20	22244,01		Ø3,5x16	22250,00		Ø4x25	22300,00		Ø7x50	22430,00		Ø4x25	22502,00		M4x12	22705,00		Ø6,8x8
A	2x		B	25x		D	5x		E	4x		F	4x		G	2x		H	2x		J	4x	
	22800,01		4	27000,00		Ø8x30	50553,00		70013,01		Ø15x13	70021,01		22601,00		T	12x	30080,00		Ø44x15	U	4x	
	32314,01		L=84	33019,00		L=310																	
	V	1x		W	1x																		

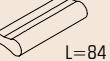
X	✓	X	✓	X	✓	X	X	X	✓

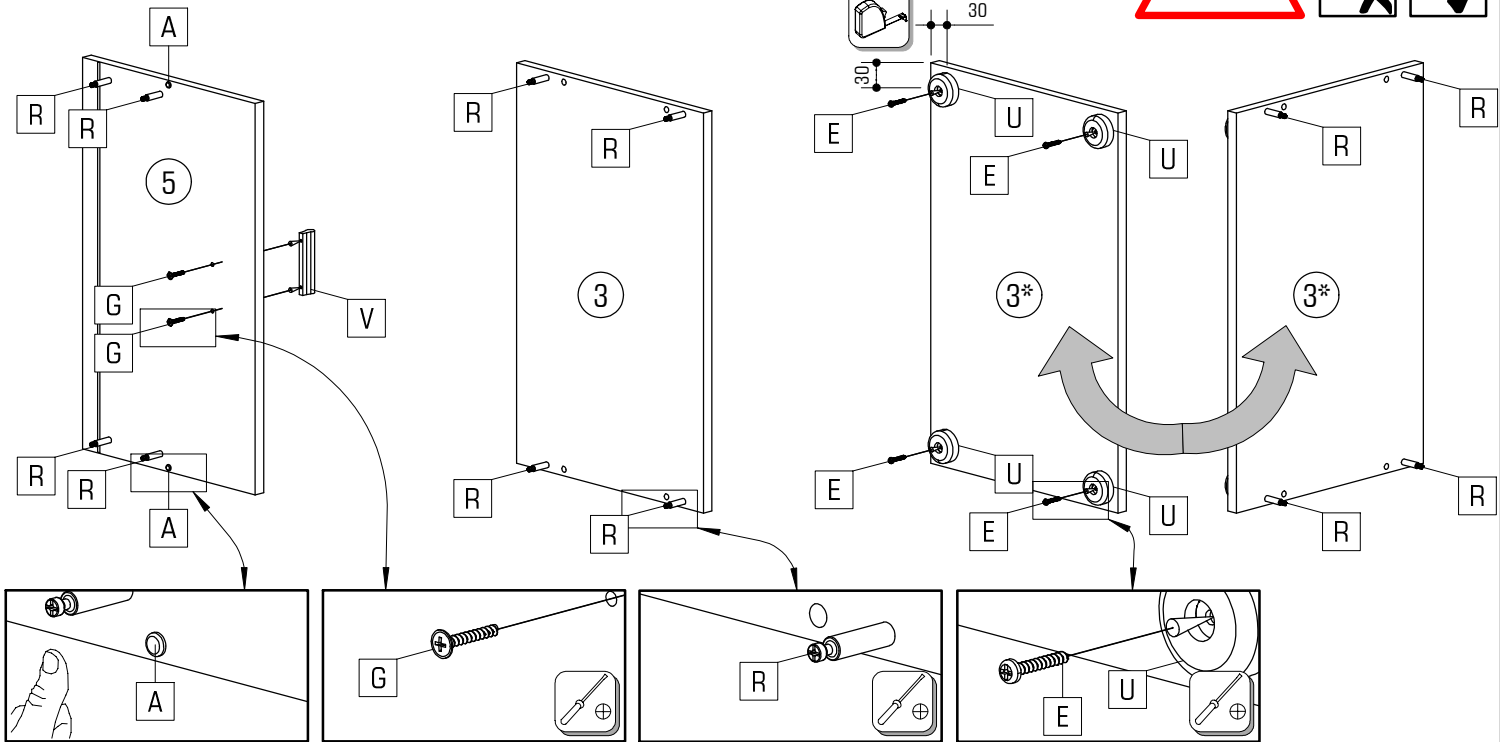
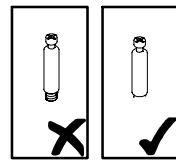
					
A 2x	E 4x	G 2x	R 12x	U 4x	V 1x

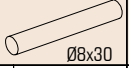

			
J 4x	M 8x	Q 12x	W 1x

